

Relay	Lane	Anders Sjöbergh	
Gundsøllille Megalink OPE	Helsingborgs Sportskytteklubb	Mp	
17.01.2020	GMO2020 Day 1	Gundsøllille OPEN 2020	
Serie 1 	1: 8.3 ➤	Serie 2 	1: 9.3 ➤
	2: 8.8 ➔		2: 7.4 ▼
	3: 8.9 ▼		3: 9.0 ➔
4: 10.7x◀	4: 7.3 ▼	5: 8.5 ➤	5: 9.1 ➔
5: 8.5 ➤	6: 10.3 ↑	6: 9.4 ↑	6: 10.3 ↑
6: 9.4 ↑	7: 7.8 ↗	7: 10.0 ↗	7: 7.8 ↗
7: 10.0 ↗	8: 7.1 ◀	8: 8.9 ↑	8: 7.1 ◀
8: 8.9 ↑	9: 8.2 ▼	9: 8.1 ▼	9: 8.2 ▼
9: 8.1 ▼	10: 8.0 ➤	10: 9.1 ◀	10: 8.0 ➤
Series 86 ( 1x)	Series 81 ( 0x)	86 ( 1x)	167 ( 1x)
Serie 3 	1: 9.3 ↑	Serie 4 	1: 9.8 ◀
	2: 6.9 ◀		2: 9.3 ▼
	3: 8.8 ➔		3: 10.0 ➔
4: 9.5 ▼	4: 8.3 ↗	5: 10.4 ▼	5: 9.5 ◀
5: 10.4 ▼	6: 7.3 ▼	6: 9.6 ↗	6: 7.3 ▼
6: 9.6 ↗	7: 9.4 ◀	7: 7.6 ◀	7: 9.4 ◀
7: 7.6 ◀	8: 10.2 ➔	8: 7.6 ◀	8: 10.2 ➔
8: 7.6 ◀	9: 10.2 ↑	9: 8.5 ◀	9: 10.2 ↑
9: 8.5 ◀	10: 7.2 ◀	10: 8.5 ▼	10: 7.2 ◀
Series 81 ( 0x)	Series 88 ( 0x)	248 ( 1x)	336 ( 1x)
Serie 5 	1: 9.3 ↑	Serie 6 	1: 7.4 ↗
	2: 10.3 ↗		2: 8.5 ◀
	3: 7.4 ↗		3: 8.0 ↗
4: 10.1 ➔	4: 7.2 ◀	5: 9.0 ◀	5: 10.1 ↗
5: 9.0 ◀	6: 9.1 ▼	6: 8.9 ↑	6: 9.1 ▼
6: 8.9 ↑	7: 8.2 ➔	7: 9.2 ➔	7: 8.2 ➔
7: 9.2 ➔	8: 10.4x➔	8: 8.3 ↑	8: 10.4x➔
8: 8.3 ↑	9: 9.8 ◀	9: 7.7 ▼	9: 9.8 ◀
9: 7.7 ▼	10: 10.0 ▼	10: 8.1 ◀	10: 10.0 ▼
Series 85 ( 0x)	Series 86 ( 1x)	421 ( 1x)	507 ( 2x)

Relay	Lane	Bjarne Obel	
Gundsøllille Megalink OPE	Rødovre Skytteforening	Mp	
17.01.2020	GMO2020 Day 1	Gundsøllille OPEN 2020	
Serie 1 	1: 7.3 ←	Serie 2 	1: 9.4 ↓
	2: 6.6 ↖		2: 9.2 →
	3: 8.5 ←		3: 7.3 ↗
4: 8.7 →	4: 9.3 ↖	5: 10.1 ←	5: 7.9 ↓
5: 7.6 ↓	6: 7.3 ↗	6: 6.2 ↗	6: 9.9 ↘
6: 9.4 ↑	7: 8.9 ↑	7: 7.9 ↓	7: 6.8 →
7: 8.9 ↑	8: 8.5 ↗	8: 6.2 ↗	8: 7.9 ↓
8: 8.5 ↗	9: 9.2 ↖	9: 9.9 ↘	9: 6.8 →
9: 9.2 ↖	10: 6.0 →	10: 6.8 →	10: 6.8 →
10: 6.0 →	Series 76 (0x)	Series 79 (0x)	
	76 (0x)		155 (0x)
Serie 3 	1: 9.9 →	Serie 4 	1: 9.3 ↑
	2: 6.9 ↖		2: 9.5 ↓
	3: 7.8 →		3: 9.3 ↖
4: 9.5 ↗	4: 5.8 ↗	5: 9.3 ↘	5: 6.8 ↓
5: 10.4x ↗	6: 10.0 →	6: 6.8 ↓	6: 8.9 ↓
6: 10.0 →	7: 9.5 ↖	7: 8.9 ↓	7: 9.1 ↗
7: 9.5 ↖	8: 9.2 ↓	8: 9.1 ↗	8: 8.5 ↗
8: 9.2 ↓	9: 9.9 ↓	9: 8.5 ↗	9: 8.7 →
9: 9.9 ↓	10: 8.7 ↖	10: 8.7 →	10: 8.7 →
10: 8.7 ↖	Series 86 (1x)	Series 80 (0x)	
	241 (1x)		321 (1x)
Serie 5 	1: 9.5 ↗	Serie 6 	1: 9.4 ↗
	2: 6.6 ↓		2: 9.9 ↑
	3: 6.5 ↖		3: 10.3 ↗
4: 9.0 ↓	4: 9.1 →	4: 9.1 →	5: 7.4 ↘
5: 6.0 ↓	5: 7.4 ↘	5: 7.4 ↘	6: 8.2 ↖
6: 8.9 ↘	6: 8.2 ↖	6: 8.2 ↖	7: 10.6x →
7: 9.6 →	7: 10.6x →	7: 10.6x →	8: 7.9 ↑
8: 6.4 ↑	8: 6.4 ↑	8: 7.9 ↑	9: 8.3 ↓
9: 10.5x ↘	9: 10.5x ↘	9: 8.3 ↓	10: 10.1 ↘
10: 6.7 ←	10: 6.7 ←	10: 10.1 ↘	10: 10.1 ↘
	Series 75 (1x)	Series 87 (1x)	
	396 (2x)		483 (3x)

Relay	Lane	Eduardo Hansen		
1	13	Gundsøllille Megalink OPE	Greve Skytteforening Mp	
17.01.2020	GMO2020 Day 1	Gundsøllille OPEN 2020		
<b>Serie 1</b>		1: 8.8 ↘ 2: 9.4 ← 3: 7.9 ↓ 4: 9.0 ↓ 5: 9.1 → 6: 9.4 ↓ 7: 8.7 ← 8: 10.5x ↓ 9: 8.8 → 10: 8.0 ← <b>Series 85 ( 1x)</b> <b>85 ( 1x)</b>	<b>Serie 2</b> 	1: 8.6 ↗ 2: 10.7x ↑ 3: 7.2 ↗ 4: 9.5 ↗ 5: 8.5 ↑ 6: 7.1 ↗ 7: 9.1 ↓ 8: 9.7 ↗ 9: 8.8 ← 10: 7.2 ↗ <b>Series 82 ( 1x)</b> <b>167 ( 2x)</b>
<b>Serie 3</b>		1: 9.4 → 2: 8.2 ↓ 3: 8.4 ↓ 4: 10.2 ↓ 5: 6.4 ← 6: 9.3 ↓ 7: 5.4 ↑ 8: 8.5 ↗ 9: 9.5 ↗ 10: 9.2 ↑ <b>Series 81 ( 0x)</b> <b>248 ( 2x)</b>	<b>Serie 4</b> 	1: 9.8 ← 2: 8.3 ↗ 3: 8.4 ↓ 4: 9.4 ↓ 5: 8.8 ↑ 6: 9.2 ↑ 7: 9.4 ↑ 8: 10.2 ↗ 9: 9.4 ↗ 10: 9.3 ↓ <b>Series 88 ( 0x)</b> <b>336 ( 2x)</b>
<b>Serie 5</b>		1: 7.6 ↑ 2: 7.2 ↓ 3: 10.1 ← 4: 8.7 ↓ 5: 7.9 ← 6: 8.6 ← 7: 9.7 ← 8: 7.9 ↓ 9: 6.8 ↑ 10: 7.7 ← <b>Series 76 ( 0x)</b> <b>412 ( 2x)</b>	<b>Serie 6</b> 	1: 8.1 ↑ 2: 7.5 → 3: 9.3 ← 4: 8.8 → 5: 9.2 ↓ 6: 9.3 ← 7: 8.7 ← 8: 10.3 ↗ 9: 7.0 ↓ 10: 9.3 ↗ <b>Series 84 ( 0x)</b> <b>496 ( 2x)</b>

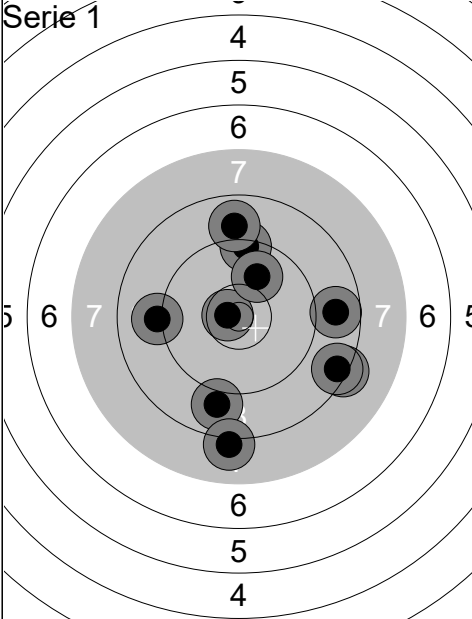
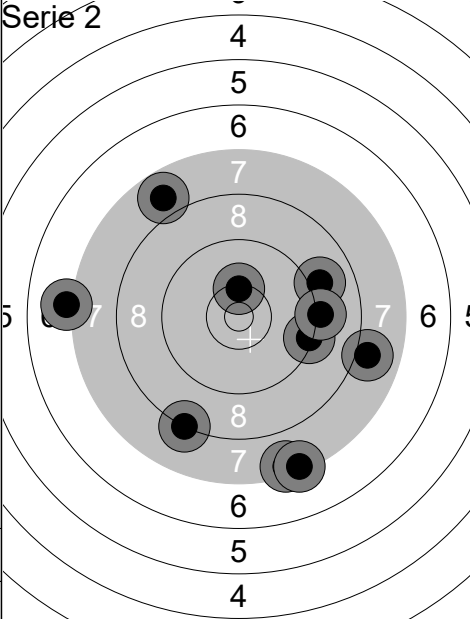
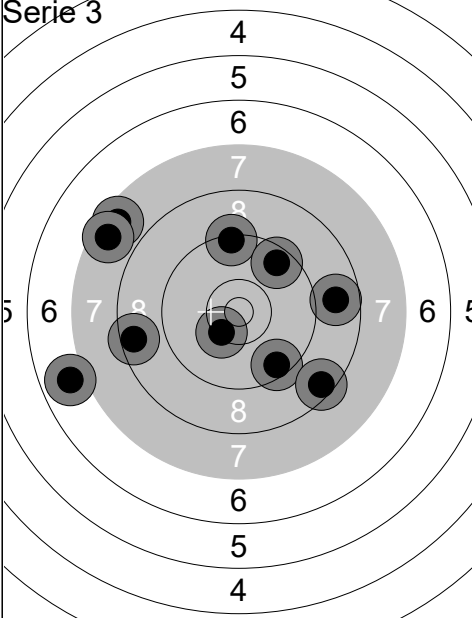
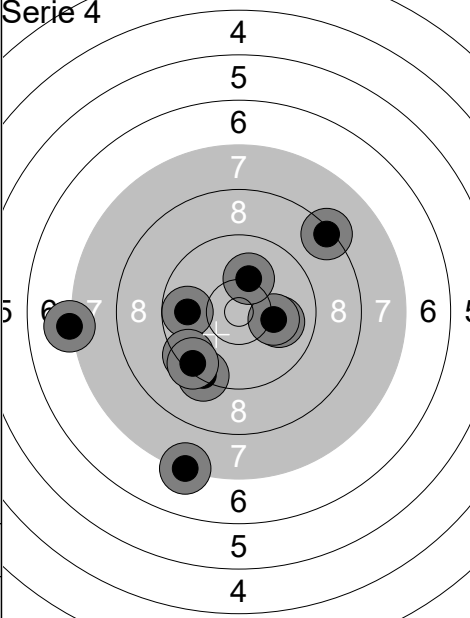
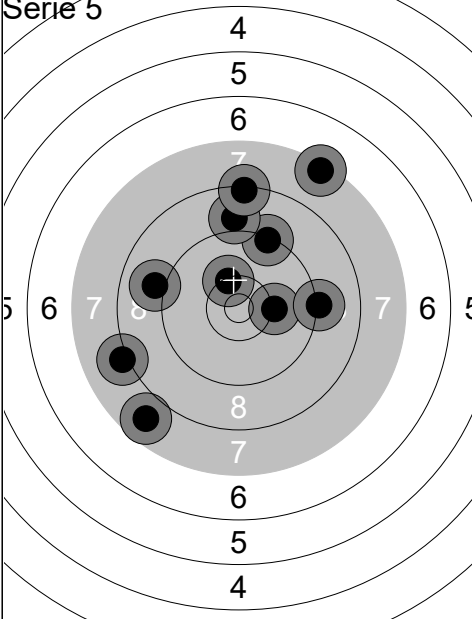
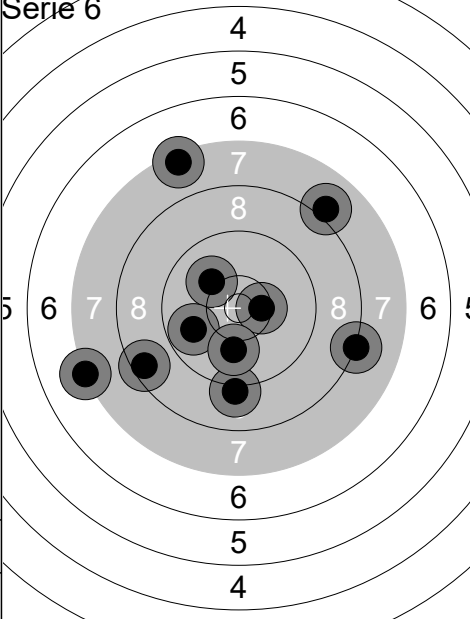
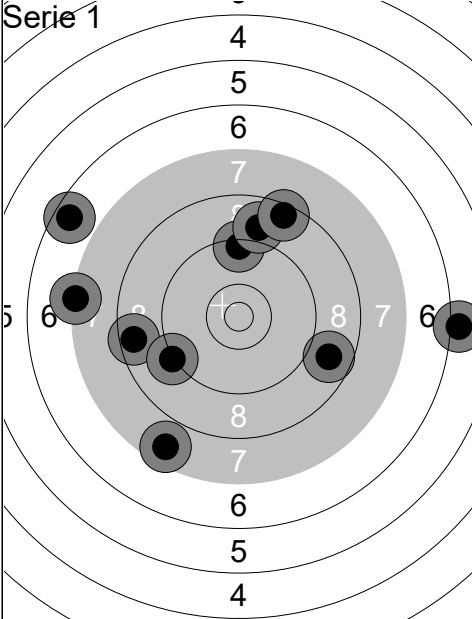
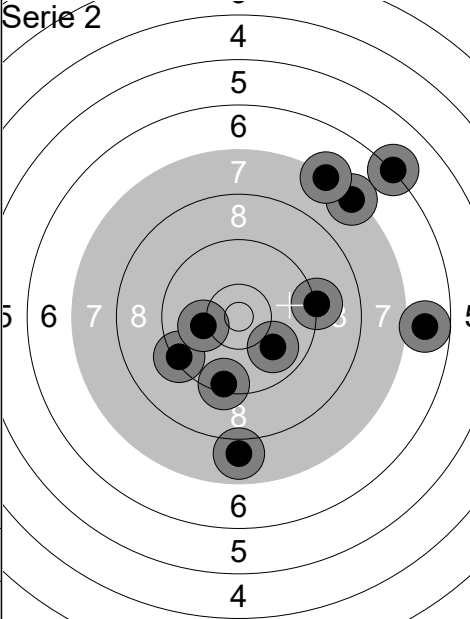
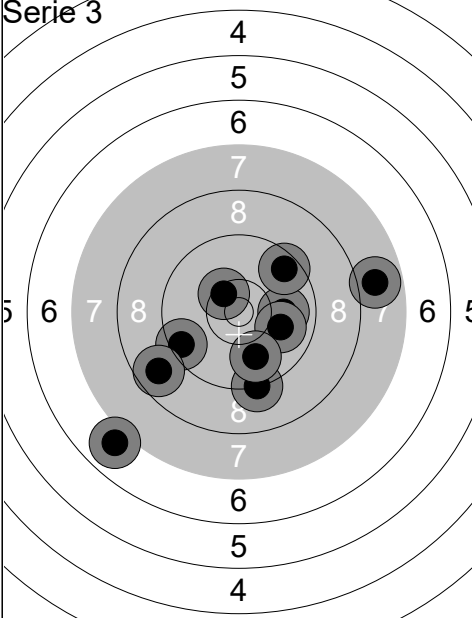
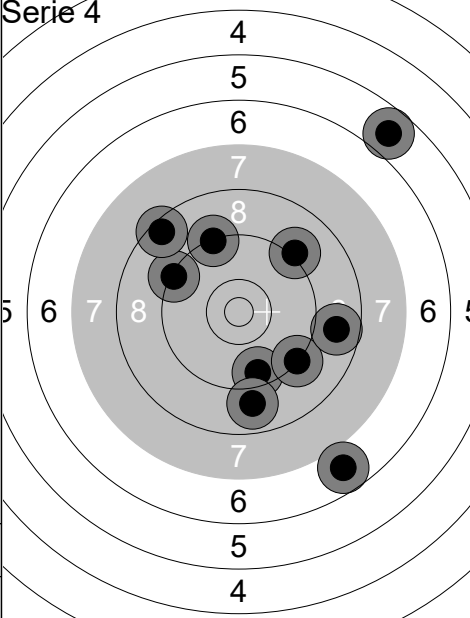
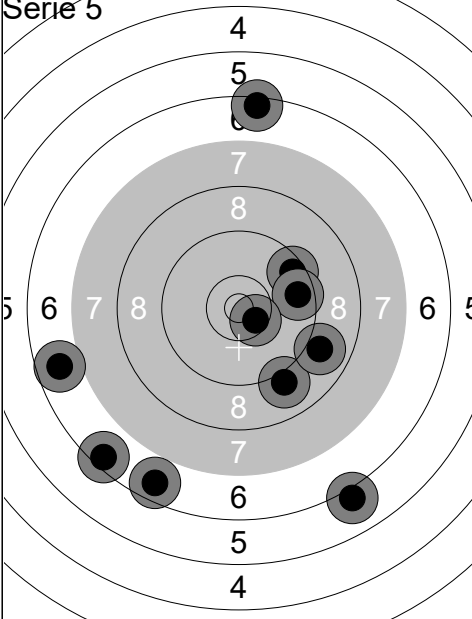
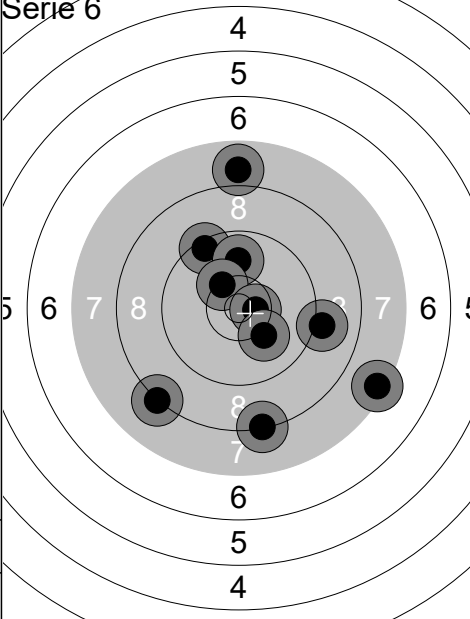
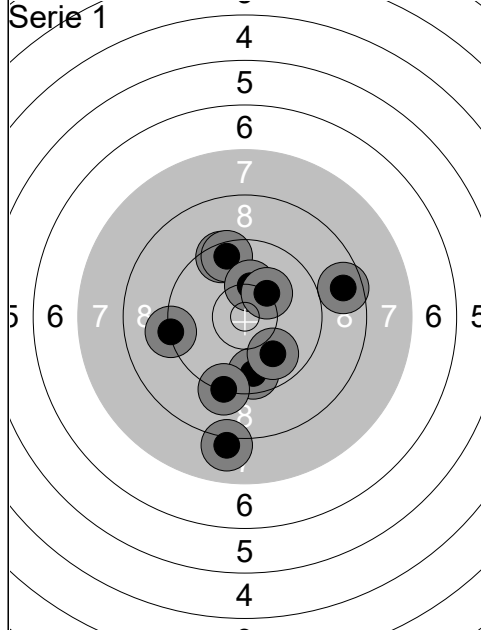

1:	9.7	↓
2:	9.9	↓
3:	9.5	↗
4:	8.0	↓
5:	8.7	→
6:	9.5	↑
7:	9.2	↓
8:	10.2	↑
9:	9.3	←
10:	10.2	↗
<b>Series</b>	<b>90 ( 0x)</b>	
	<b>90 ( 0x)</b>	

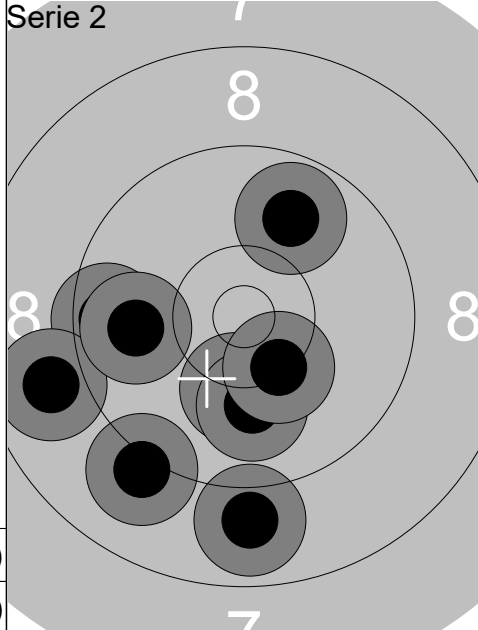

1:	9.6	←
2:	10.2	↓
3:	8.9	←
4:	9.8	←
5:	10.2	↓
6:	10.1	↓
7:	9.1	↘
8:	9.8	↗
9:	10.3	↘
10:	8.9	↓
<b>Series</b>	<b>92 ( 0x)</b>	
	<b>182 ( 0x)</b>	

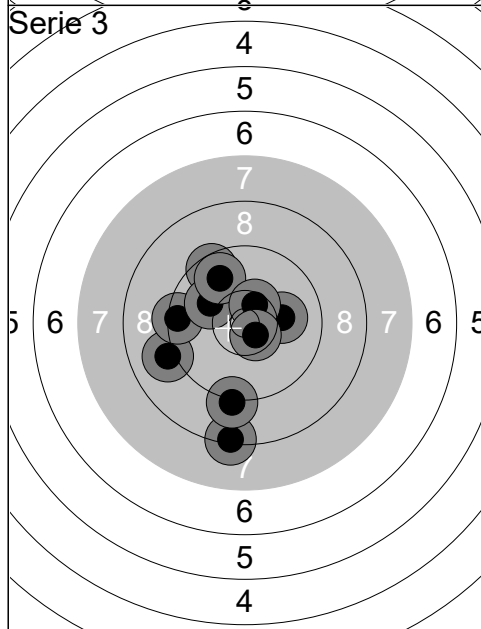

1:	8.3	↓
2:	9.5	↗
3:	9.1	←
4:	9.4	←
5:	10.1	→
6:	10.0	↖
7:	9.8	↗
8:	10.5x	↗
9:	10.6x	↘
10:	9.1	↓
<b>Series</b>	<b>93 ( 2x)</b>	
	<b>275 ( 2x)</b>	

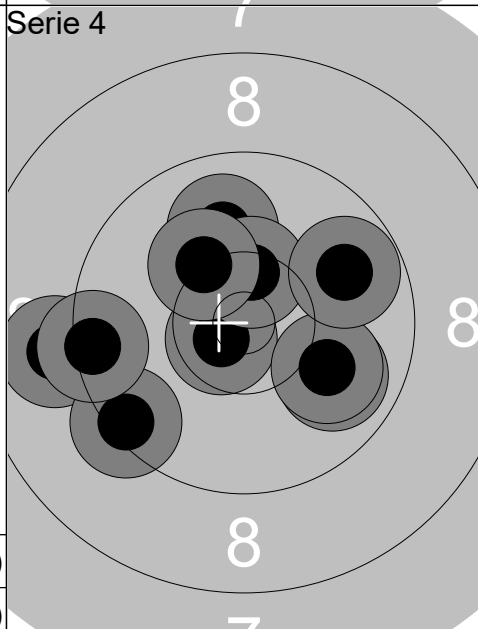

1:	9.9	↘
2:	10.0	↑
3:	10.7x	↖
4:	10.0	↘
5:	9.0	←
6:	9.4	↖
7:	10.4x	↑
8:	10.2	↗
9:	9.4	←
10:	9.8	↗
<b>Series</b>	<b>95 ( 2x)</b>	
	<b>370 ( 4x)</b>	

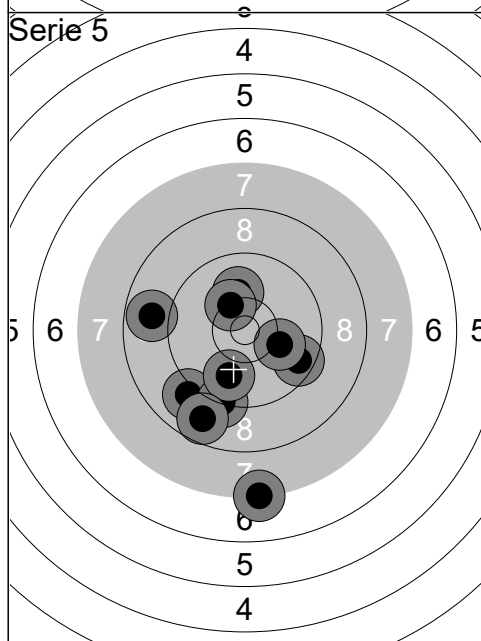

1:	9.6	↘
2:	10.1	↑
3:	10.3	↗
4:	7.2	↓
5:	10.1	→
6:	9.0	↖
7:	9.3	↓
8:	9.9	↓
9:	8.8	↓
10:	8.8	←
<b>Series</b>	<b>89 ( 0x)</b>	
	<b>459 ( 4x)</b>	

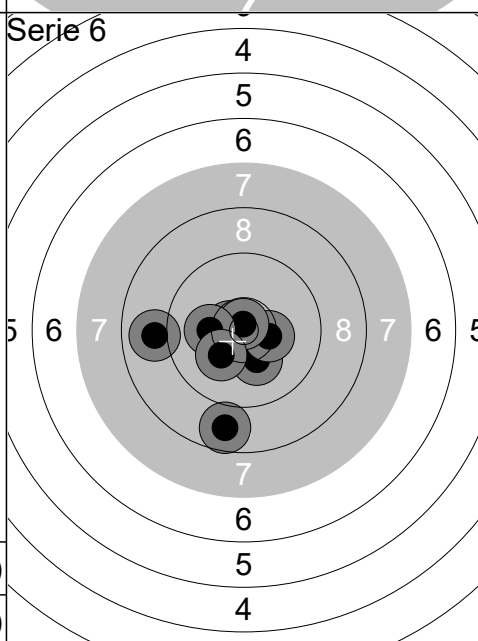

1:	10.5x	↘
2:	10.6x	←
3:	8.9	←
4:	10.2	↓
5:	10.6x	←
6:	10.4x	→
7:	10.8x	↑
8:	8.7	↓
9:	10.2	←
10:	10.2	↖
<b>Series</b>	<b>96 ( 5x)</b>	
	<b>555 ( 9x)</b>	

Relay	Lane	Jonas Kofoed Hansen	
Gundsøllille Megalink OPE	Vejle Skytteforening	Mp	
17.01.2020	GMO2020 Day 1	Gundsøllille OPEN 2020	
<b>Serie 1</b>	1: 9.9 ↓ 2: 8.9 ↙ 3: 10.4x ↘ 4: 10.3 ↓ 5: 9.6 ← 6: 9.3 ↗ 7: 10.1 ↓ 8: 9.8 ↓ 9: 10.6x → 10: 10.3 → <b>Series 94 ( 2x)</b> 94 ( 2x)	<b>Serie 2</b>	1: 9.5 ↑ 2: 10.2 ↗ 3: 10.3 ↖ 4: 10.5x ↘ 5: 9.2 ↗ 6: 9.4 ↓ 7: 8.6 ↗ 8: 10.0 ↗ 9: 9.7 → 10: 8.4 ↓ <b>Series 92 ( 1x)</b> 186 ( 3x)
<b>Serie 3</b>	1: 10.3 ← 2: 9.3 ↓ 3: 9.7 ↓ 4: 10.3 ← 5: 9.6 ← 6: 10.0 ← 7: 10.2 ← 8: 10.1 ↑ 9: 9.8 ← 10: 9.5 ← <b>Series 95 ( 0x)</b> 281 ( 3x)	<b>Serie 4</b>	1: 10.2 → 2: 9.4 → 3: 9.9 ← 4: 10.6x ↗ 5: 9.7 → 6: 10.4x ↗ 7: 10.5x ← 8: 9.6 ↑ 9: 9.4 ↑ 10: 9.5 ← <b>Series 94 ( 3x)</b> 375 ( 6x)
<b>Serie 5</b>	1: 10.1 ← 2: 10.1 ↓ 3: 9.5 ↓ 4: 9.8 ↗ 5: 10.4x ↓ 6: 8.7 ↓ 7: 10.0 ↓ 8: 9.9 ↑ 9: 9.4 → 10: 9.7 ↓ <b>Series 93 ( 1x)</b> 468 ( 7x)	<b>Serie 6</b>	1: 9.9 → 2: 9.9 ↗ 3: 7.9 ↓ 4: 9.4 ↓ 5: 10.0 → 6: 9.4 ↖ 7: 9.9 ← 8: 9.3 ↓ 9: 10.3 ↖ 10: 9.0 ← <b>Series 90 ( 0x)</b> 558 ( 7x)

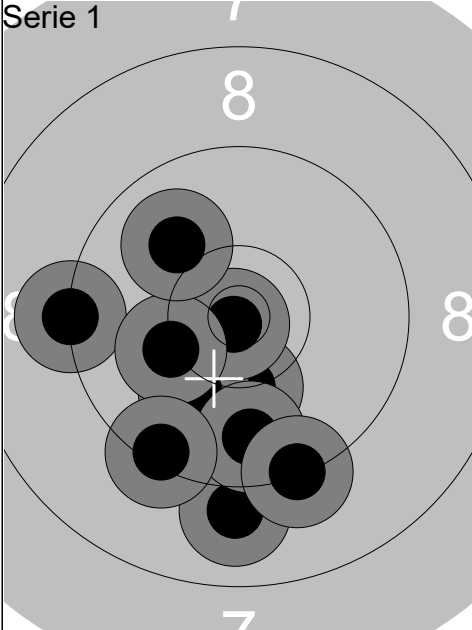
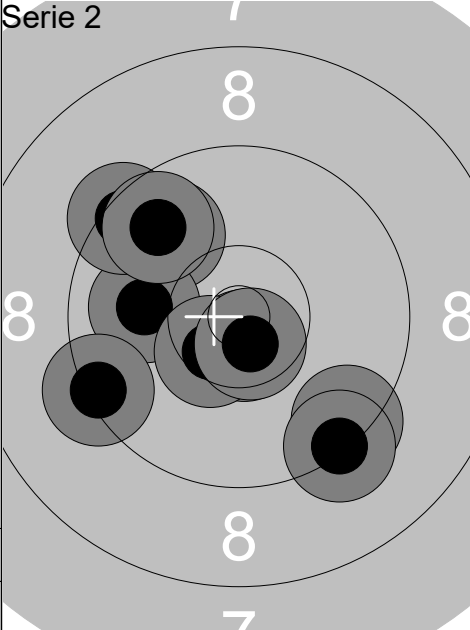
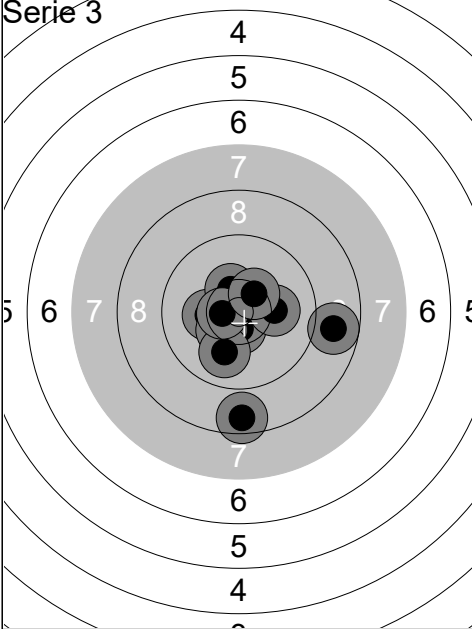
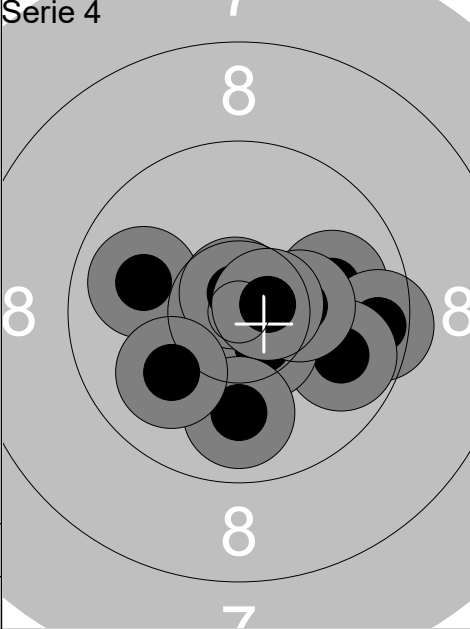
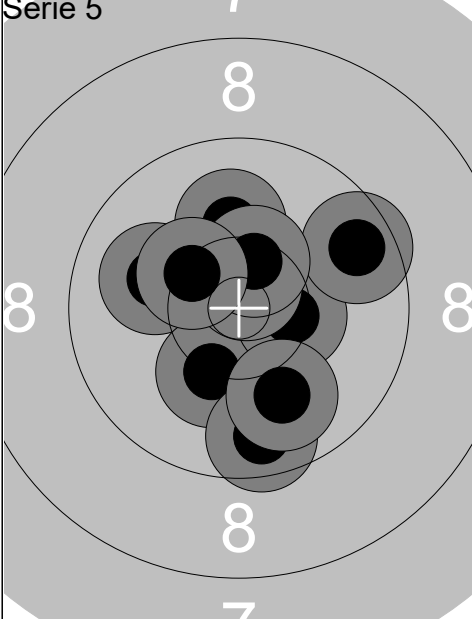
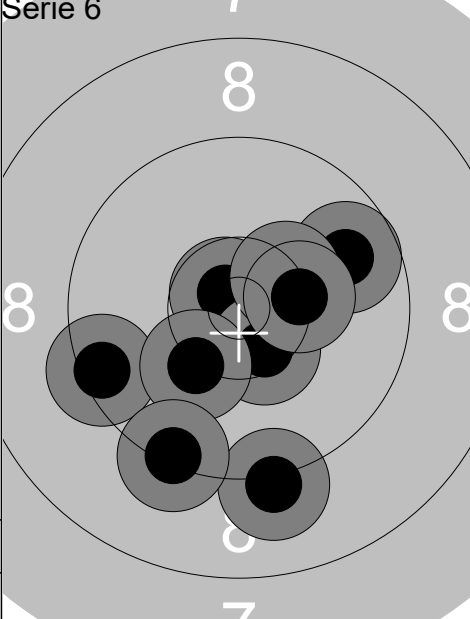
Relay	Lane	Frederik Larsen	
Gundsøllille Megalink OPE		DSB/ASF	Mp
17.01.2020		GMO2020 Day 1	Gundsøllille OPEN 2020
Serie 1			1: 9.2 ← 2: 10.2 ↓ 3: 9.0 ↓ 4: 10.1 ↙ 5: 9.7 ↓ 6: 10.9x ↙ 7: 9.3 ↓ 8: 10.2 ← 9: 9.4 ↙ 10: 10.0 ↗ Series 95 ( 1x) 95 ( 1x)
Serie 2			1: 10.6x ↓ 2: 9.9 ↗ 3: 10.0 ← 4: 10.5x ↙ 5: 9.4 ↗ 6: 9.3 ← 7: 9.7 ↗ 8: 9.4 ↓ 9: 10.6x ↓ 10: 9.3 ↓ Series 94 ( 3x) 189 ( 4x)
Serie 3			1: 10.6x ↓ 2: 8.6 ↓ 3: 10.3 ← 4: 10.4x ↙ 5: 10.0 ↓ 6: 10.2 → 7: 10.4x ↗ 8: 10.6x ← 9: 8.8 → 10: 10.4x ↗ Series 96 ( 5x) 285 ( 9x)
Serie 4			1: 10.0 → 2: 9.9 ← 3: 9.5 → 4: 9.8 → 5: 10.5x ↙ 6: 10.3 → 7: 10.8x ↑ 8: 10.6x → 9: 9.9 ↓ 10: 10.0 ↙ Series 96 ( 3x) 381 ( 12x)
Serie 5			1: 10.1 ↑ 2: 10.0 ← 3: 10.3 ↓ 4: 10.4x → 5: 10.7x ↗ 6: 9.6 ↓ 7: 10.0 ↓ 8: 9.6 ↗ 9: 10.4x ↗ 10: 10.4 ↙ Series 98 ( 3x) 479 ( 15x)
Serie 6			1: 9.1 ↓ 2: 9.4 ← 3: 9.8 → 4: 10.9x ↙ 5: 10.7x ↙ 6: 10.4x ↙ 7: 10.2 ↓ 8: 9.3 ↓ 9: 10.4x ↗ 10: 10.3 → Series 96 ( 4x) 575 ( 19x)

Gundsøllille Megalink Open 2020

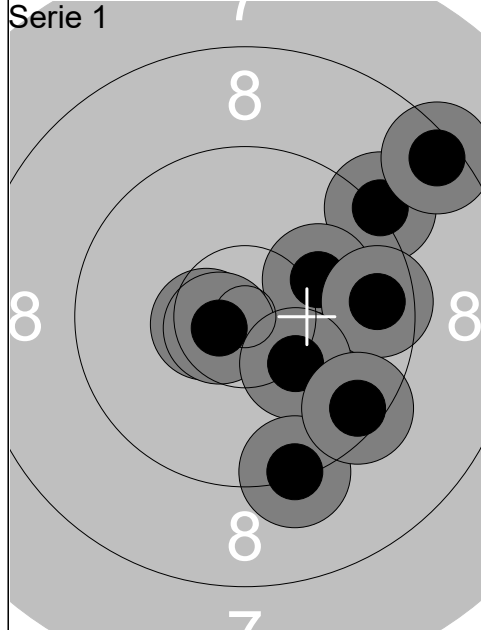

1:	10.5x ←
2:	9.2 ↗
3:	10.1 ↗
4:	10.7x ←
5:	10.2 ↘
6:	8.4 ↗
7:	9.6 →
8:	10.2 ↘
9:	9.3 ↘
10:	9.5 ↘
<b>Series</b>	<b>94 ( 2x)</b>
	<b>94 ( 2x)</b>

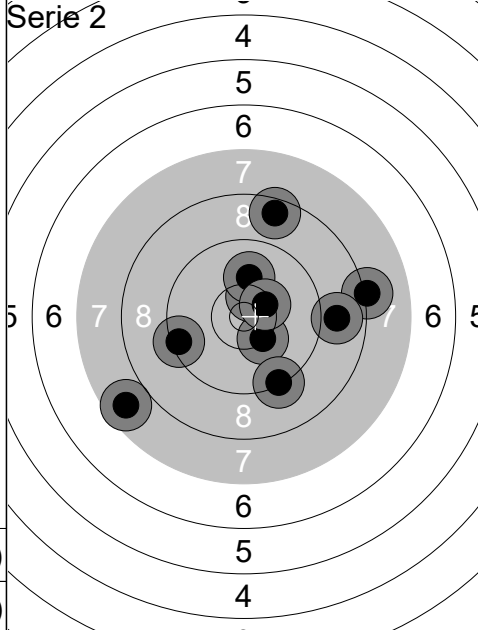

1:	10.3 ↘
2:	8.2 →
3:	9.3 ↘
4:	8.9 →
5:	7.7 ←
6:	8.5 ↑
7:	10.5x ↑
8:	10.1 ↑
9:	10.4x ↗
10:	9.4 ←
<b>Series</b>	<b>89 ( 2x)</b>
	<b>183 ( 4x)</b>

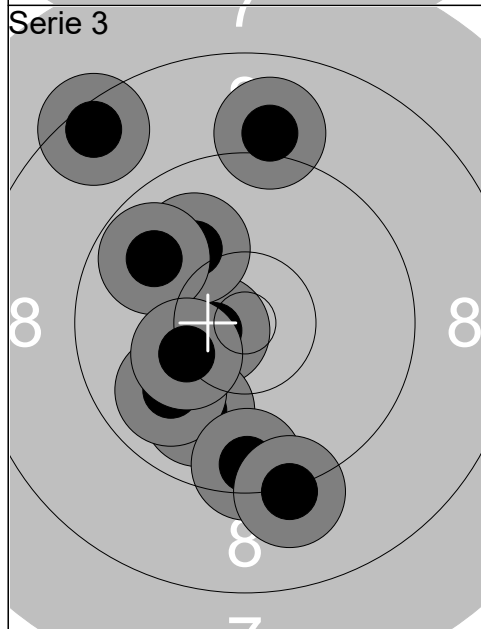

1:	10.6x ←
2:	9.9 ↘
3:	9.9 ←
4:	8.5 ↗
5:	9.5 ↘
6:	9.0 ↑
7:	9.2 ↘
8:	10.0 ↗
9:	9.8 ↗
10:	10.3 ←
<b>Series</b>	<b>92 ( 1x)</b>
	<b>275 ( 5x)</b>

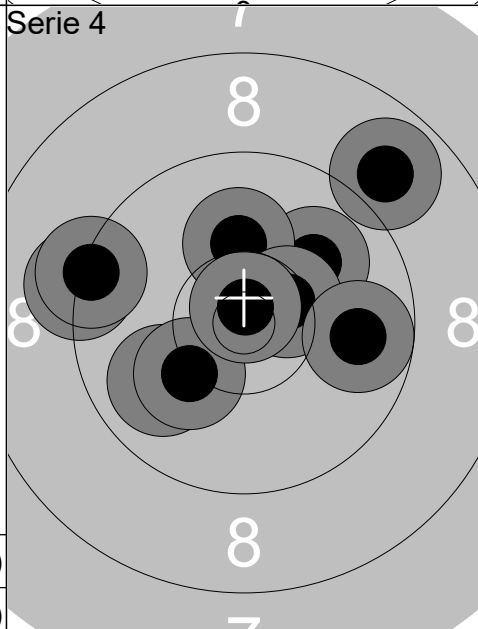

1:	9.9 ←
2:	8.9 ↗
3:	10.0 ↗
4:	10.2 ↘
5:	10.1 ↑
6:	9.2 ←
7:	10.5x ↗
8:	9.8 →
9:	10.8x ↑
10:	9.3 ←
<b>Series</b>	<b>94 ( 2x)</b>
	<b>369 ( 7x)</b>

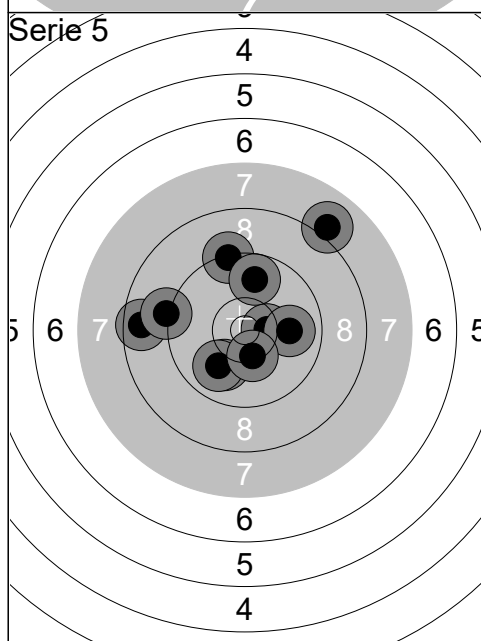

1:	10.5x →
2:	9.9 →
3:	10.0 ↘
4:	8.6 ←
5:	9.2 ←
6:	8.0 ↗
7:	10.0 ↘
8:	9.3 ↑
9:	9.8 ↑
10:	10.3 ↘
<b>Series</b>	<b>92 ( 1x)</b>
	<b>461 ( 8x)</b>

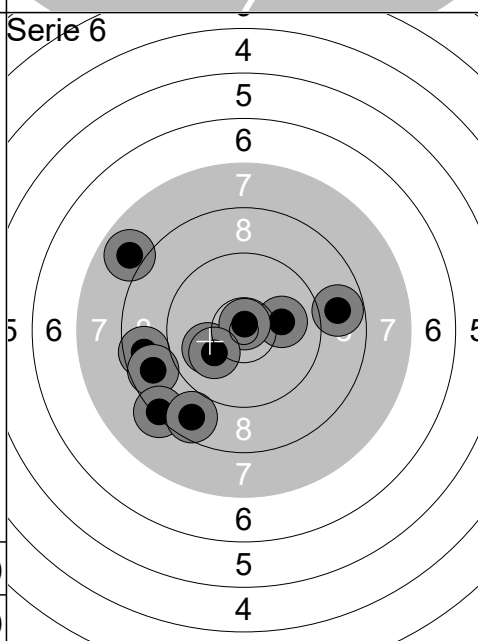

1:	8.7 ←
2:	10.1 →
3:	8.8 →
4:	10.0 ←
5:	10.8x ↑
6:	10.1 ←
7:	8.7 ←
8:	7.9 ↗
9:	8.3 ↘
10:	8.7 ↘
<b>Series</b>	<b>87 ( 1x)</b>
	<b>548 ( 9x)</b>

Relay	Lane	Mayank Marwah	
1	18	India	Mp
17.01.2020	GMO2020 Day 1	Gundsøllille OPEN 2020	
<b>Serie 1</b> 	1: 9.4 ↘ 2: 8.9 ↓ 3: 9.6 ↘ 4: 8.8 ↘ 5: 10.2 ↓ 6: 9.4 ← 7: 9.0 → 8: 10.5x ← 9: 7.9 ← 10: 10.3 ↓ <b>Series 89 ( 1x)</b> <b>89 ( 1x)</b>	<b>Serie 2</b> 	1: 7.9 ← 2: 8.9 ↓ 3: 9.7 ↓ 4: 10.2 ↘ 5: 8.4 → 6: 8.0 ← 7: 9.1 → 8: 8.6 ↓ 9: 9.8 ↓ 10: 9.7 ← <b>Series 85 ( 0x)</b> <b>174 ( 1x)</b>
<b>Serie 3</b> 	1: 9.5 ↓ 2: 7.3 ↓ 3: 10.0 ↓ 4: 9.9 ↑ 5: 9.3 ↓ 6: 9.1 ↓ 7: 8.9 → 8: 9.1 ↓ 9: 8.3 ↓ 10: 8.2 → <b>Series 86 ( 0x)</b> <b>260 ( 1x)</b>	<b>Serie 4</b> 	1: 6.9 ↓ 2: 9.0 ← 3: 10.1 ← 4: 9.9 ↓ 5: 10.2 ↓ 6: 10.4x ← 7: 8.9 ↑ 8: 8.1 → 9: 8.6 ↓ 10: 9.2 ↓ <b>Series 87 ( 1x)</b> <b>347 ( 2x)</b>
<b>Serie 5</b> 	1: 8.5 ← 2: 9.3 → 3: 10.4x ↑ 4: 9.9 → 5: 9.1 ← 6: 10.0 ↑ 7: 10.4 ↓ 8: 9.4 ← 9: 9.8 ← 10: 9.4 ↓ <b>Series 92 ( 1x)</b> <b>439 ( 3x)</b>	<b>Serie 6</b> 	1: 9.8 ← 2: 10.4x ↖ 3: 10.5x ↗ 4: 9.4 ← 5: 8.8 ↓ 6: 10.8x ↓ 7: 9.2 ↓ 8: 10.6x ↖ 9: 6.9 ← 10: 6.1 ↓ <b>Series 87 ( 4x)</b> <b>526 ( 7x)</b>



Relay	Lane		
<b>1</b>	<b>19</b>	<b>Malik Bazara</b>	
Gundsøllille Megalink OPE		Helsingør Salonskytte Forening	Mp
17.01.2020		GMO2020 Day 1	Gundsøllille OPEN 2020
<b>Serie 1</b> 	1: 9.5 ←	<b>Serie 2</b> 	1: 10.7x ↗
	2: 9.8 ↗		2: 9.5 →
	3: 10.1 ↗		3: 9.8 ↓
	4: 9.2 ↑		4: 9.8 ←
	5: 7.5 ↘		5: 9.7 ←
	6: 7.7 ↘		6: 9.6 ↘
	7: 10.7x →		7: 8.9 ↗
	8: 9.5 →		8: 7.2 ←
	9: 9.0 ↓		9: 9.1 ↑
	10: 10.4x ←		10: 9.3 →
	Series 89 ( 2x)		Series 88 ( 1x)
	89 ( 2x)		177 ( 3x)
<b>Serie 3</b> 	1: 9.8 →	<b>Serie 4</b> 	1: 7.2 ←
	2: 8.5 ↘		2: 8.3 ↓
	3: 10.1 ↓		3: 10.3 ↓
	4: 10.0 ↘		4: 10.3 ↑
	5: 8.9 ↑		5: 9.7 ↓
	6: 10.3 ↑		6: 8.3 ↑
	7: 9.5 ↗		7: 9.5 ↗
	8: 9.8 ↗		8: 9.7 ←
	9: 9.0 →		9: 9.2 ↑
	10: 10.7x ↑		10: 9.6 ↗
	Series 92 ( 1x)		Series 88 ( 0x)
	269 ( 4x)		357 ( 4x)
<b>Serie 5</b> 	1: 6.7 ←	<b>Serie 6</b> 	1: 9.5 ↘
	2: 9.1 ↗		2: 8.9 →
	3: 8.6 ↑		3: 9.3 ↘
	4: 9.5 ←		4: 9.6 →
	5: 10.0 ↗		5: 9.5 ←
	6: 8.4 ↑		6: 8.8 ↑
	7: 10.0 ↗		7: 9.5 →
	8: 8.6 →		8: 9.9 ↑
	9: 10.1 →		9: 10.5x ←
	10: 8.8 →		10: 9.5 ↓
	Series 86 ( 0x)		Series 89 ( 1x)
	443 ( 4x)		532 ( 5x)

Relay	Lane	Manvendra Prasad		
1	20	India	Mp	
17.01.2020	GMO2020 Day 1	Gundsøllille OPEN 2020		
<b>Serie 1</b>		1: 8.1 ↙ 2: 8.6 ↑ 3: 10.7x ← 4: 8.9 ← 5: 10.6x ↑ 6: 9.9 ← 7: 9.3 ↘ 8: 7.3 ← 9: 9.4 → 10: 10.1 ↓ <b>Series 88 ( 2x)</b> <b>88 ( 2x)</b>	<b>Serie 2</b>	
				1: 9.1 ← 2: 10.1 ↗ 3: 8.9 ↘ 4: 10.4x ↙ 5: 9.4 → 6: 10.0 ↓ 7: 9.8 ↗ 8: 8.4 ↓ 9: 9.9 ↗ 10: 9.0 → <b>Series 91 ( 1x)</b> <b>179 ( 3x)</b>
<b>Serie 3</b>		1: 9.1 ↗ 2: 10.2 → 3: 8.8 → 4: 10.3 → 5: 9.8 ← 6: 8.6 ← 7: 8.6 ← 8: 10.2 → 9: 10.1 ↑ 10: 8.0 → <b>Series 90 ( 0x)</b> <b>269 ( 3x)</b>	<b>Serie 4</b>	
				1: 10.0 ↓ 2: 10.4x ↑ 3: 10.6x ↓ 4: 9.5 ← 5: 7.3 ↓ 6: 7.4 ← 7: 9.6 ← 8: 9.7 ↗ 9: 10.3 ↑ 10: 9.4 → <b>Series 90 ( 2x)</b> <b>359 ( 5x)</b>
<b>Serie 5</b>		1: 9.3 ↗ 2: 8.0 → 3: 9.3 → 4: 10.5x ↗ 5: 8.7 ↘ 6: 9.2 ↘ 7: 8.9 ↘ 8: 8.6 → 9: 7.5 ↘ 10: 9.5 ← <b>Series 85 ( 1x)</b> <b>444 ( 6x)</b>	<b>Serie 6</b>	
				1: 7.5 ↗ 2: 7.1 ← 3: 8.2 ↓ 4: 9.3 ↓ 5: 9.6 ↗ 6: 7.3 ↓ 7: 9.2 ↗ 8: 9.0 ↘ 9: 10.0 → 10: 8.4 ↗ <b>Series 83 ( 0x)</b> <b>527 ( 6x)</b>

Relay	Lane	Ragnar Skanåker	
1	21	Gundsøllille Megalink OPE	Helsingborgs Sportskytteklubb
17.01.2020		GMO2020 Day 1	Gundsøllille OPEN 2020
Serie 1		1: 9.7 ← 2: 10.3 ↘ 3: 10.5x ↗ 4: 8.3 ← 5: 10.5x ↓ 6: 9.9 ↑ 7: 9.5 ↓ 8: 10.0 ← 9: 9.6 ↑ 10: 9.8 ← Series 93 ( 2x) 93 ( 2x)	Serie 2 1: 9.4 → 2: 8.9 ↗ 3: 9.7 ← 4: 9.8 → 5: 9.6 ↗ 6: 9.6 ↓ 7: 10.0 ↓ 8: 9.7 ↑ 9: 9.6 ↓ 10: 9.9 ↗ Series 90 ( 0x) 183 ( 2x)
Serie 3		1: 9.2 ↑ 2: 8.8 ↑ 3: 8.5 → 4: 9.8 ↗ 5: 9.8 ↑ 6: 7.8 → 7: 8.7 ← 8: 10.2 ↑ 9: 9.1 ← 10: 9.4 ↑ Series 86 ( 0x) 269 ( 2x)	Serie 4 1: 8.4 ↑ 2: 8.0 ← 3: 10.1 → 4: 9.2 ↗ 5: 10.0 ↑ 6: 10.1 ↗ 7: 9.3 ↑ 8: 9.3 ← 9: 10.1 ← 10: 8.3 ↑ Series 91 ( 0x) 360 ( 2x)
Serie 5		1: 9.9 ↙ 2: 8.8 ↗ 3: 9.2 ↓ 4: 9.7 ↗ 5: 10.7x → 6: 8.9 ↑ 7: 9.8 ↗ 8: 8.6 ↑ 9: 8.9 ↑ 10: 10.2 ← Series 88 ( 1x) 448 ( 3x)	Serie 6 1: 8.5 ↑ 2: 10.0 ← 3: 9.1 ← 4: 10.3 ← 5: 8.0 ← 6: 10.0 ↓ 7: 8.3 ↑ 8: 9.7 ↓ 9: 8.3 ← 10: 8.3 ↗ Series 88 ( 0x) 536 ( 3x)